

OMCONNECT
SMART KEYBOX-K12
USER GUIDE

What's Included

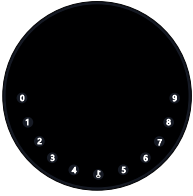

1 x Key Box



1 x HELLO Card



2 x Screw Cap

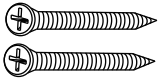

2 x Mounting Screws



2 x Screws Anchors



1 x Reset Tool

Specification

Model	K12
Material	Body Zinc Alloy, SUS304
Battery	4 x AAA Alkaline Battery
Unlock Mechanism	Bluetooth, PIN Code, App
Jump Start	USB-C

Front

120mm (4- 7/10'')

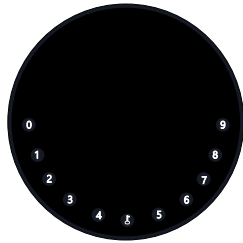

Inside

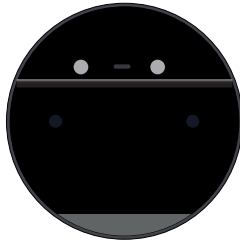

Depth

22mm (4/5 '')

Back

120mm (4- 7/10'')

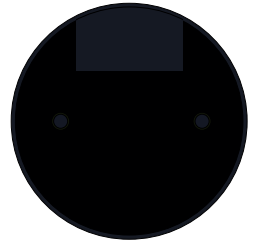

120mm (4- 7/10'')

120mm (4- 7/10'')

Features

Lock&Unlock



Administrator Unlock

Set a Master Administrator PIN for Unlocking, settings, operations etc. and only the administrator could change the administrator PIN code.



Anti-peeping

Add up to 8-12 digits before and after PIN code to intensify your PINs.

Mobile Control



Bluetooth one-touch unlock

With your Mobile you could unlock the keybox by touching the UNLOCK key on the App.



Mobile Administrator

Set Administrator PIN Codes from your Mobile to unlock, add users, delete users, etc.

Battery



Battery Life

4 AAA batteries, the life cycle will be more than 12 months, please use good batteries.



Low Consumption

BLE broadcasting turns to sleep mode if no operations.

Emergency



Jump Start

When the power is down and use USB-C to jump start the lock and get it unlocked

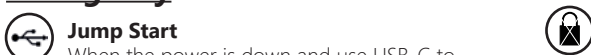

System Lockdown

The lock will be lockdown for 5 minutes if continuously enter wrong PINs for 5 times.



User Unlock

This KeyBox allows to add up to 100 user PIN codes for your family, friends and visitors.



Auto Locking

If there is no opening motions in 10 seconds the box will be automatically locked.



Offline Unlock

You could generate offline code through mobile App, for scheduled access, parcel delivery, house keeping, etc.

Quick Start

Step 1 > Install Battery

>. Remove the (4) screws on the battery cover

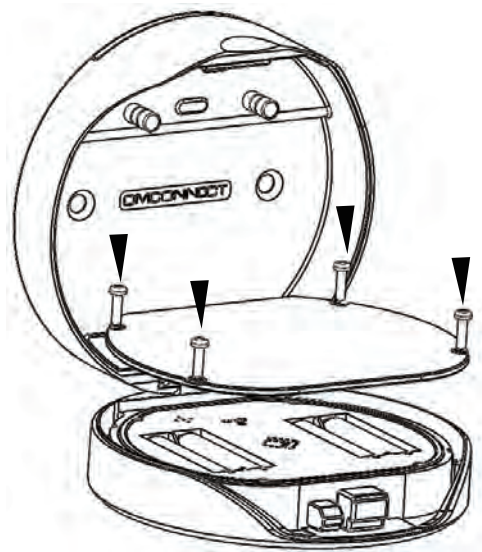

>. Put 4 AAA batteries into the battery dock.

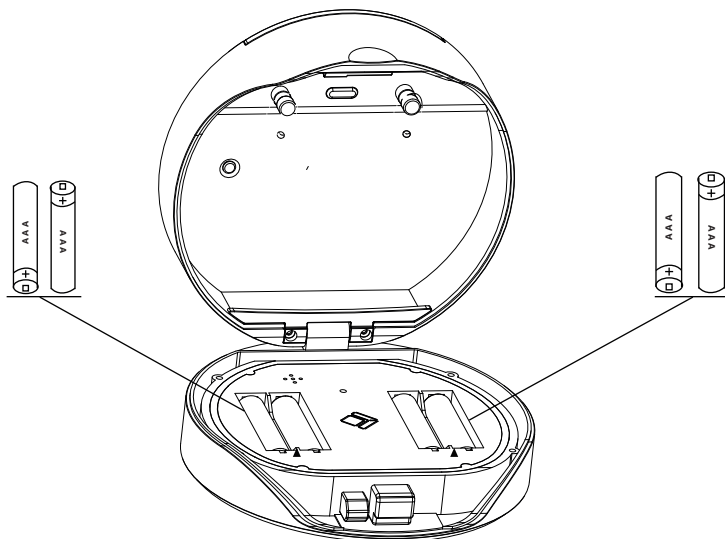

Step 2>Download Mobile App

>1. Scan QR Code below and download the App and turn on your mobile Bluetooth



Step 3>Add Device

>1. Go to App Home page, click Add Device or click "+" on the upper right.

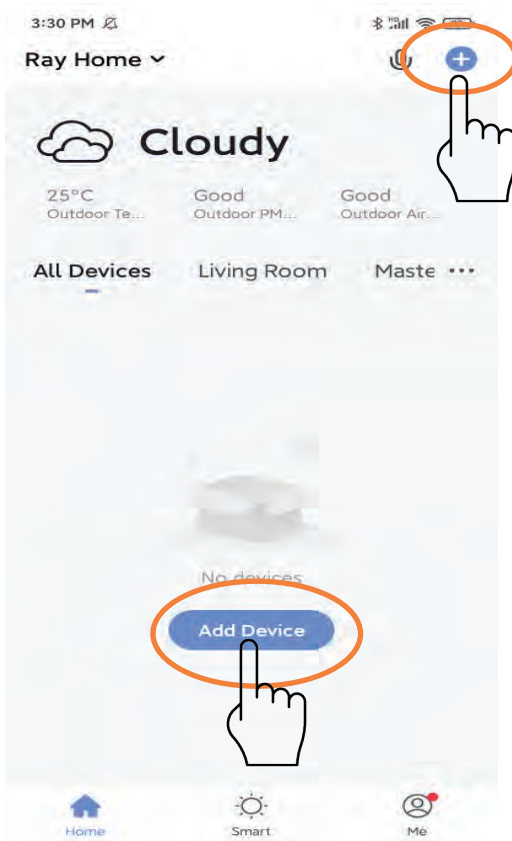

> **2.** Press the "Reset" button and hold it for 3 beeps to start pairing

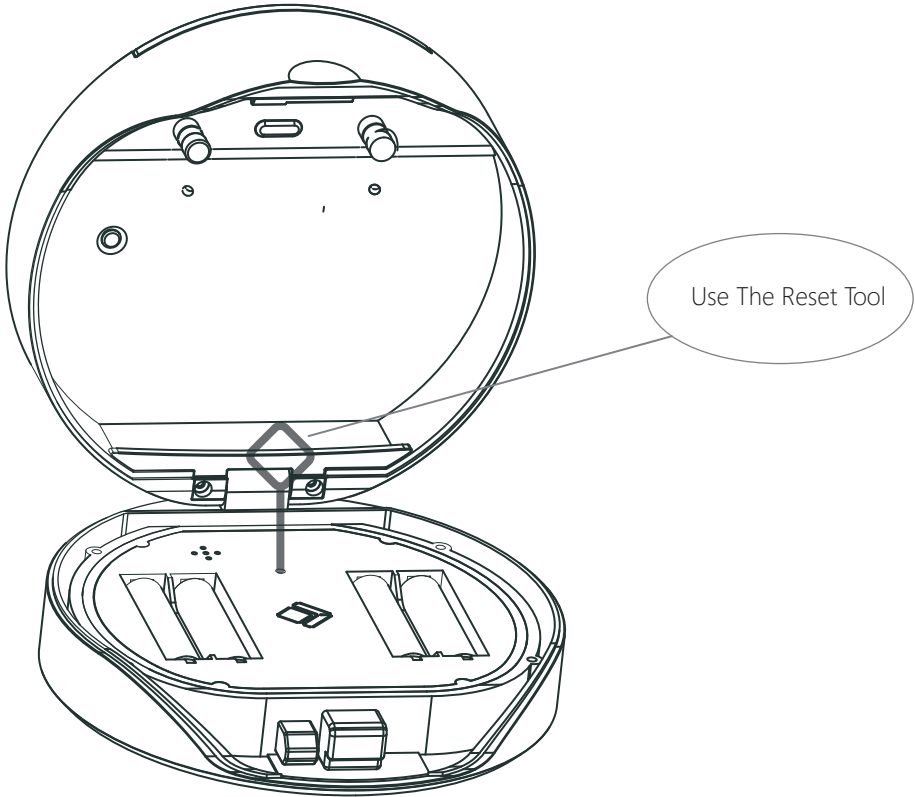

>3. You will see the detected device and click "Go to add".

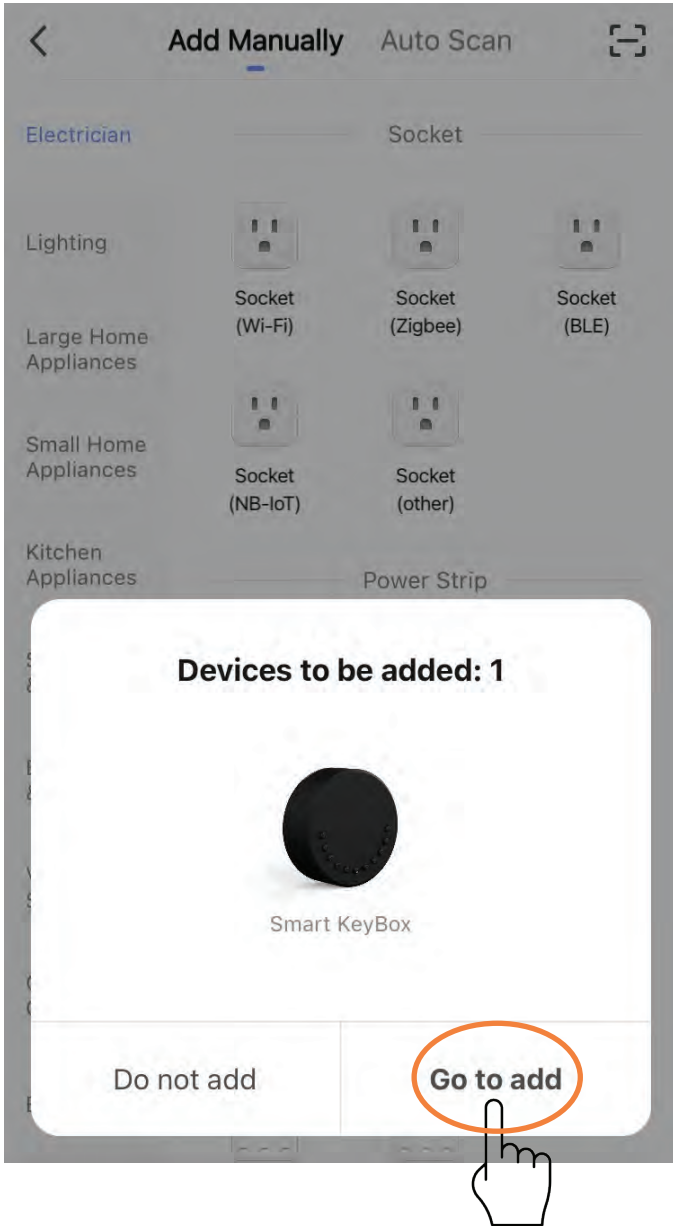

>4. Connecting, you need to wait for few seconds to let it finish.

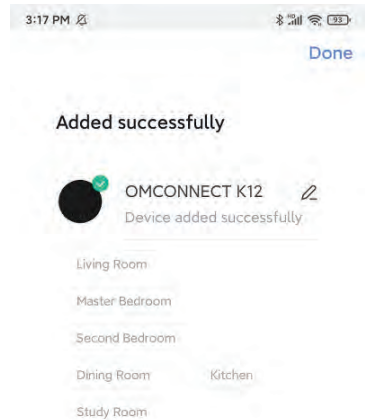

>5. Device added

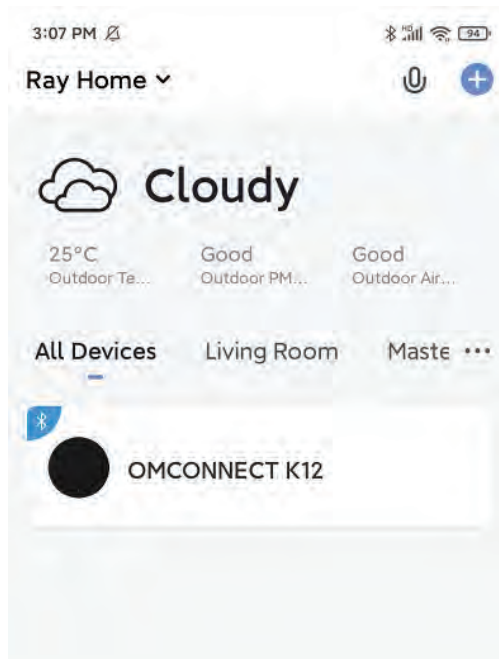

Step 4>Change Admin Password-Initial Admin Password:123456

>1. Press the Enter Button and hold for 3 beeps

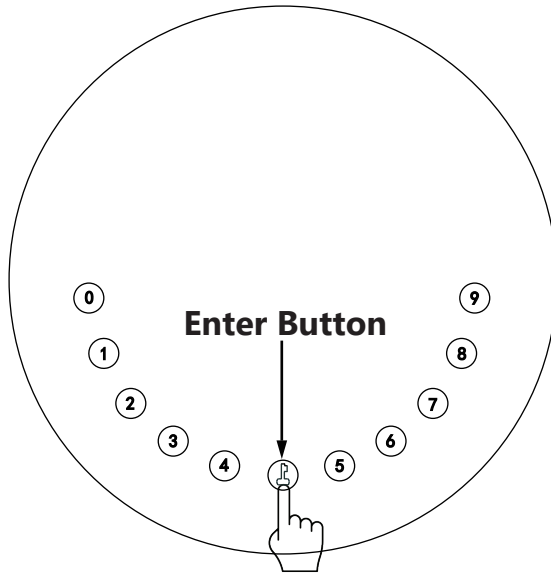

>2. Right after the 3 beeps please key in:

Initial Admin Password + Enter Button+New Admin password+Enter Button

Mechanical Instructions

Password & Factory Mode:

1. Password Length

Password must be 6 digits(no more no less)

2. Add User PIN

Press Enter and hold for 3 beeps, Admin PIN + enter + user PIN + enter + user PIN + enter

3. Modify User PIN

Enter + 1 + Enter, PIN to be modified + enter + New PIN + enter + New PIN + Enter

4. Delete User PIN

Enter + 2 + Enter, Admin PIN + PIN to be deleted + enter

5. Delete All User PINs

Enter + 00000 +Enter + Admin PIN and wait for 3 seconds

6. Virtual digits-Anti Peeping

Add any digits before and after the correct password the KeyBox unlock as always

7. System Lockdown

KeyBox will Lockdown for 5 minutes if entering wrong password continuously 5 times

8. Reset Factory Mode

Press and hold the reset button for 5seconds and with a long beep

Bluetooth broadcasting & re-connecting:

Press and hold the reset button for 3 beeps, you will be able to pair the device.

Bluetooth broadcasting will turn to sleep mode if no operations within 1 minute.

Press any key to activate the Bluetooth, App&Device will get reconnected each other.

App Instructions



☑ You will see all devices and rooms on the home page.

☑ Tap the Device to start operating.

☑ Tap "Me" at the bottom to manage your home.

☑ Touch the lock sign to unlock and lock.

☑ Tap "Bell" sign to check the alarm records.

☑ Tap "Member Management" to add or delete members.

☑ Tap "opening record" to check opening logs.

☑ Tap "Intelligent Linkage" to turn on and off go home mode.

☑ Tap "Set" to manage passwords



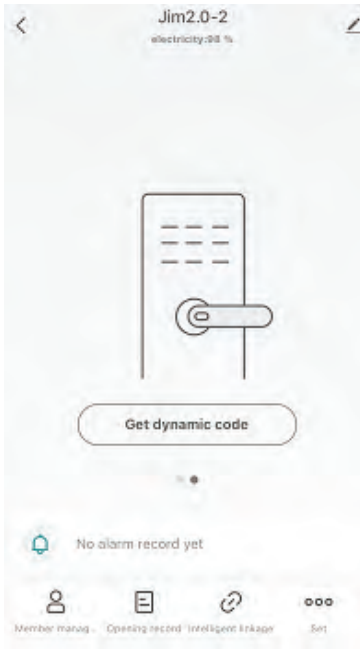

☑ Tap “Get dynamic code” to get a code.

☑ Tap “copy code” and send it to friend or family.

☑ Tap “Pen” sign to edit your personal information.

☑ Tap “+” to add family member or others.

☑ Tap added members to edit member’s information.

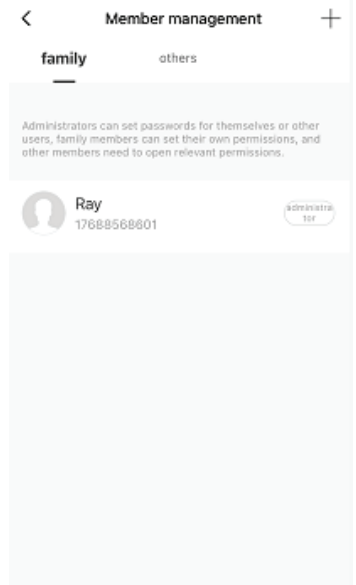

You will find out when and who unlocked the KeyBox

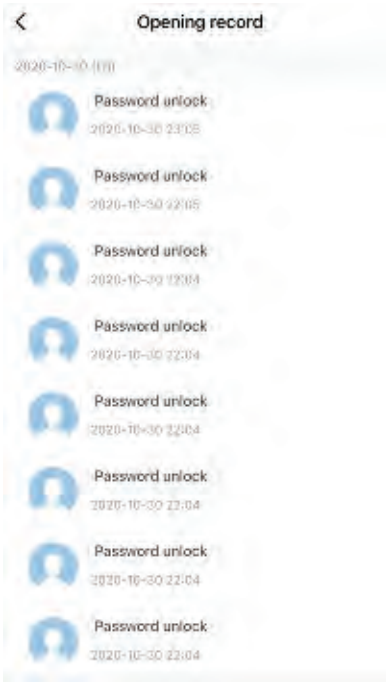

Tap the green bar and save to turn on the function.

Tap the orange bar and save to turn on the function.

You will get notification if user unlocked with bluetooth

Go to "me" homepage and got to message center to check the records.

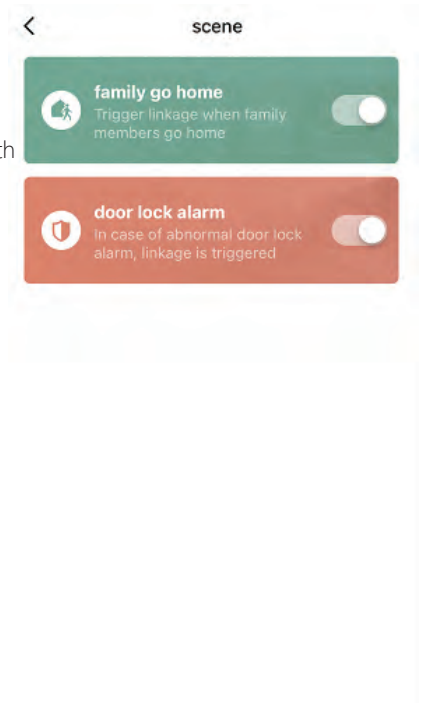



Set



password man... Temporary pas...

Intelligent linkage



☑ Tap "password management" to add or remove codes.

☑ Tap "Temporary code" to manage online and offline codes.

☑ Tap "one time code" under Online Code to set a online one time code.

☑ Tap "periodic Code" under Online Code to set a online code which will be available in a period of time.

☑ Tap "One Time Code" under Offline Code to generate a one time offline code which will be a 10 digits code and use it when the device is offline.

☑ Tap "Offline Temporary Code" under Offline Code to generate a offline code(10 digits) which will be available in a period of time, and use when the device is offline or Bluetooth disconnected with device.

☑ Tap "Clear Code" to generate a code(10 digits) which is able to clear Codes that need to be invalid or clear all codes.

☑ Please note if the code less than 10 digits you need to regenerate a new code, the code must be 10 digits.



Temporary Code

Online Code

It is recommended for BLE connections

One Time Code

It can be used only once during the validity period

Periodic Code

Can be used multiple times within the validity period

Offline Code

It is recommended to use when BLE is disconnected or in a poor BLE environment

One Time Code

It can be used only once during the validity period

Offline Temporary Code

Please use it at least once within 24 hours after it takes effect, or it will be invalid

Clear Code

OMCONNECT

Copyright © 2020 OMFOCUS TECH. All rights reserved. www.omconnect.com

Designed in France Made in China